



Genesis Series

5,5 to 22 kW



Air. Anytime. Anywhere.



Join the ABAC advantage

Since 1980, ABAC offers the right mix of flexibility and experience for the industrial, professional and DIY compressed air markets. From state-of-the-art production facilities straight to your business via more than 300 distributors in more than 100 countries worldwide, ABAC provides you with plug & play air solutions with a quality label. We deliver trouble free workmates, both piston as well as screw compressors, that are always available and ready to use.



Join today thousands of convinced customers operating millions of ABAC compressors worldwide.

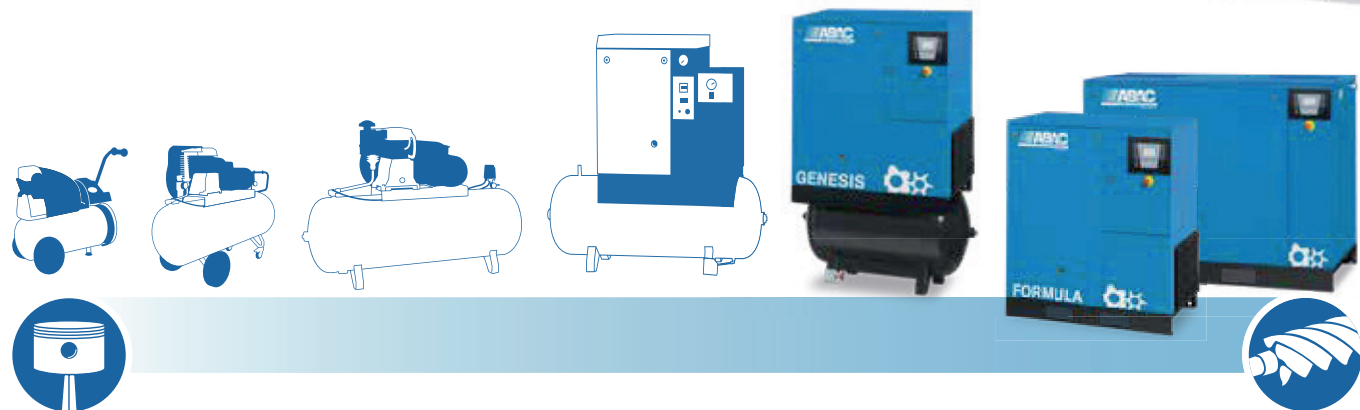

The Reference workstation

The legendary Genesis, that's a truly plug & play solution for air delivery, or just everything you need in one place for far less space.

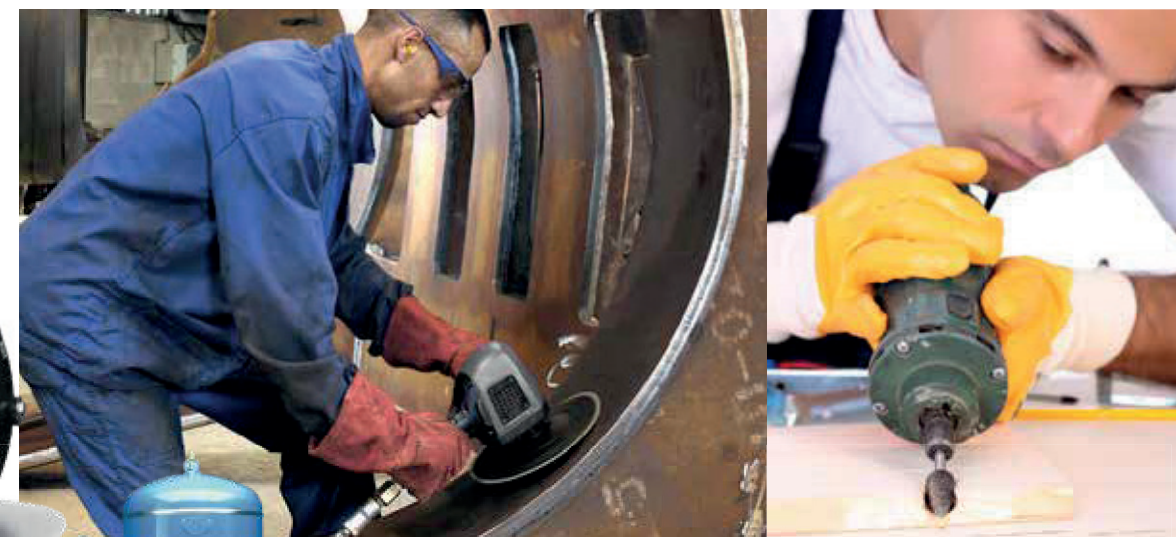

The Genesis concept

A compressed air installation usually requires many different components: a compressor, a receiver, a cyclonic separator, a refrigerant dryer, drains and a post filter. All of this can now be replaced by only one thing: the Genesis workstation. A unique integrated solution!

Our famous user friendliness

Thanks to an intuitive control panel, you have a clear overview of all key parameters and system menus - so in a few touches you can easily drive your Genesis. Besides, all the maintenance components like air, oil filters and belts are ideally positioned to enable an ultimately fast and secure maintenance.

Dedicated service kits support reliable and efficient operation and include all original parts in one single package. ABAC provides you with a simple solution based on the running hours of your compressor. All parts easy at hand while providing highest protection of your investment!



Today, we are only 3 steps away from running your complete air equipment:

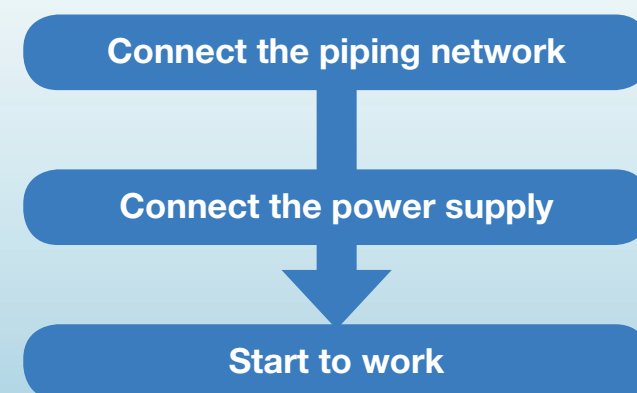

Easiness without compromising on completeness, robustness or efficiency

- Full option air for your ease: all versions include special features refrigerant dryer, automatic drain, line filter (0,1 micron) & vessel.
- Extreme robustness and outstanding reliability provided by high performance air ends.
- As efficient as large industrial compressors with low maintenance, low energy consumption, low service input and optimal installation tuning.
- Variable speed version, wherever energy saving counts even more.

Genesis, or how ABAC makes full feature compressed air easy: we tune it upfront for you.



Genesis Series

5,5 to 22 kW

Fixed speed



Type	Ltr	kW	HP	l/min	cfm	l/min	cfm	l/min	cfm	dB(A)	L x W x H (mm)	Kg
Genesis 5,5	270	5,5	7,5	880	31,1	700	24,7	-	-	62	1150 x 665 x 1687	338
	500										1935 x 665 x 1689	426
Genesis 7,5	270	7,5	10	1240	43,8	1080	38,1	830	29,3	63	1150 x 665 x 1687	346
	500										1935 x 665 x 1689	431
Genesis 11	270	11	15	1675	59,2	1510	53,3	1210	42,7	65	1150 x 665 x 1687	366
	500										1935 x 665 x 1689	451
Genesis 15	270	15	20	2330	82,3	2110	74,5	1690	59,7	67	1150 x 665 x 1687	367
	500										1935 x 665 x 1689	455
Genesis 18	500	18,5	25	3110	109,8	2720	96,1	2300	81,2	69	1939 x 805 x 1841	624
Genesis 22	500	22	30	3650	128,9	3240	114,4	2770	97,8	70	1939 x 805 x 1841	640

Variable Speed



Min



Max



Type	Ltr	kW	HP	Bar	l/min	cfm	l/min	cfm	dB(A)	L x W x H (mm)	Kg
Genesis 7,5 I	270	7,5	10	5-13	125	4,4	1200	42,4	63	1150 x 665 x 1687	355
	500									1935 x 665 x 1689	440
Genesis 11 I	270	11	15	5-13	380	13,4	1750	61,8	65	1150 x 665 x 1687	375
	500									1935 x 665 x 1689	460
Genesis 15 I	270	15	20	5-10	620	21,9	2310	81,6	67	1150 x 665 x 1687	377
	500			5-13	485	17,1	1865	65,9		1935 x 665 x 1689	462
Genesis 18 I	500	18,5	25	5-10	575	20,3	2935	103,6	69	1939 x 805 x 1841	635
				5-13	490	17,3	2465	87,1			
Genesis 22 I	500	22	30	5-10	625	22,1	3390	119,7	70	1939 x 805 x 1841	680
				5-13	530	18,7	3050	107,7			

* Unit performance measured according to ISO 1217. Noise level measured according to ISO 2151. Reference conditions: instake air pressure 1bar, 20°C and 70% RH.

Genesis

Fixed speed compressors



Only 1,24 m² (5,5 - 15 kW Series, 500 L)

Compact design

The Genesis Series compresses and processes high quality air on a minimal space.



Only 0,70 m² (5,5 - 15 kW Series, 270 L)



Dry and clean air, ready to use

Every Genesis is built with a generously sized dryer that grants you moisture free air at all times. All units are also equipped with an efficient filtration system that filters solid and liquid particles up to 0.1 micron. The result is simple: dry and clean air suitable for most of the industrial applications.

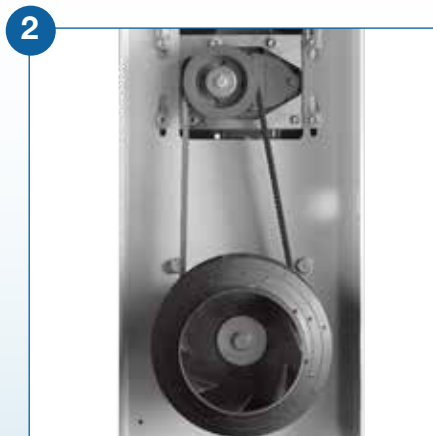

Plug and play maintenance

Good positioning of all service items such as belts, oil and air filters plus an external oil level indicator enable you to have an ultimately easy and fast maintenance. Long service intervals and smart maintenance kits make the user friendly experience more complete.



Full control in a few clicks

The Infologic2/Airlogic2 controllers give you easy access to menus and all key performance indicators necessary to drive your operation. It also features remote control interface with up to 6 compressors, programmed routine maintenance, fault log and other functions.

Genesis I

Variable speed compressors



New generation air ends

The new generation air ends guarantees you superior FAD efficiency, more robustness and the reliability of a manufacturer who assembles 25.000 of these air ends every year.

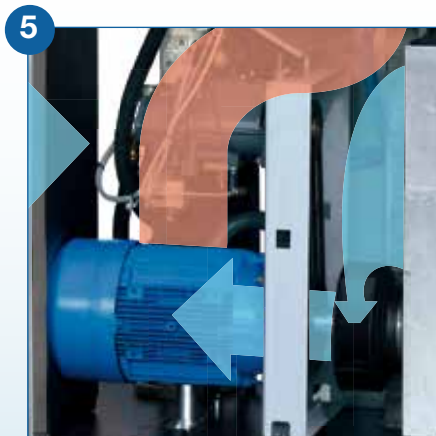

Standard efficiency included for a long lifetime at low cost

Powerful independent motor cooling guaranteeing ideal temperatures even on extreme conditions; high efficiency air/oil aluminium cooler block.



No loss automatic condensate drain

The noise free automatic condensate drain discharges only water. There is no waste of air. This silent process respects your working environment.

Your additional benefits from using variable speed compressors

During most of the time, the air consumption in your network is not constant. A variable speed compressor reduces the speed of the main motor to follow precisely the profile of compressed air consumption. This results in considerable saving on your energy bill..

Full variable speed efficiency benefits

Soft start: reduces the current on start, protecting the motor and reducing power consumption.

EMC Compliant: no electromagnetic interference to or from your power network.

Constant air pressure to any value between 5-13 bar: Maintaining a constant target pressure ensure no unloaded operation and subsequent wasted energy is avoided

High efficiency motor: more energy efficiency through the use of IE3 motors.

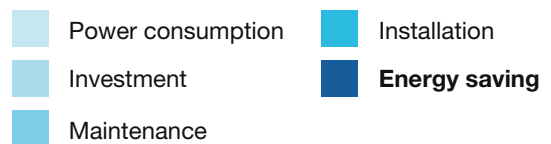
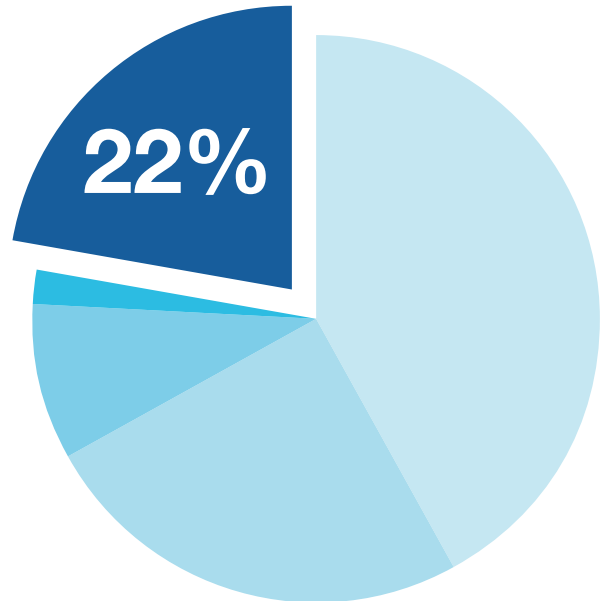

See how your Genesis works

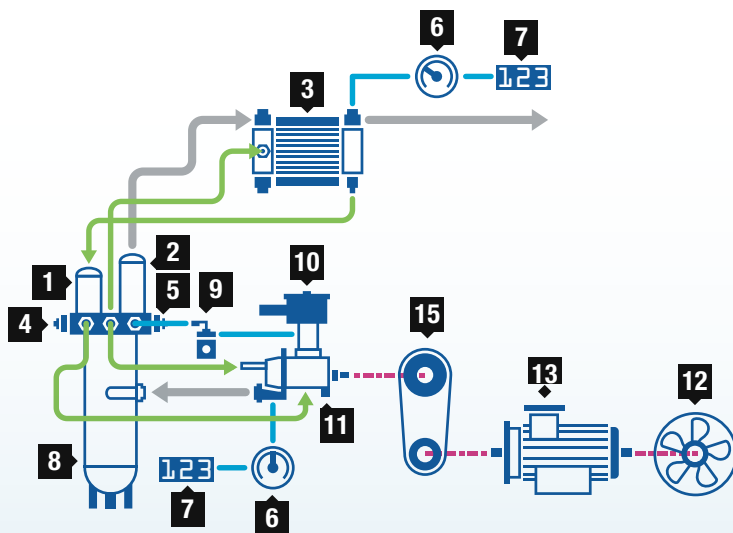

- Compressed Air
- Air/Oil
- Oil
- 1. Oil filter
- 2. Air/Oil separator filter
- 3. Air/Oil cooler
- 4. Thermostatic valve
- 5. Safety valve
- 6. Pressure control
- 7. Display
- 8. Oil tank
- 9. Suction electro valve
- 10. Air suction filter
- 11. Air end
- 12. Cooling fan
- 13. Electric motor
- 14. Temperature control
- 15. Transmission group

Full comfort air wherever you need it

Space efficient design, uncompromised noise levels thanks to generous insulation and easy handling via two access points: ABAC enables you to install the Genesis device close to your workspace, save on piping network and still keep the comfort.

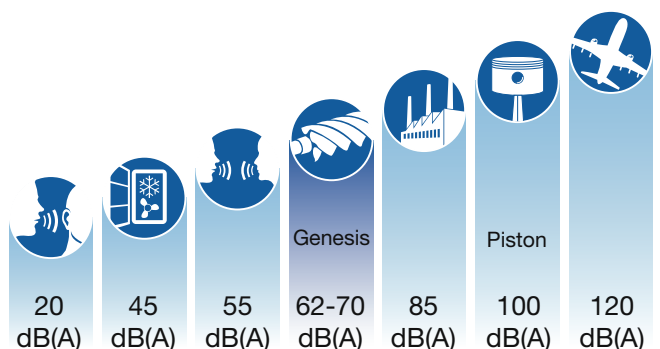

The world of ABAC



Original parts.
Your quality assurance.

Your Authorised Distributor

6998960072

The 'original part' identification confirms that these components passed our strict test criteria. All parts are designed to match the compressor and are approved for use on the specified compressor. They have been thoroughly tested to obtain the highest level of protection, extending the compressors' lifetime and keeping the cost of ownership to an absolute minimum. No compromises are made on reliability. The use of 'original part' certified quality components helps ensure reliable operation and will not impact the validity of your warranty, unlike other parts. Look for your quality assurance.



www.abacaircompressors.com

Air. Anytime. Anywhere.